

# Data Sheet



Article number: 12516800240500  
Description: KLEE-coil 516 800 240.500  
M4 Stainless 1.4305

## Measures

---

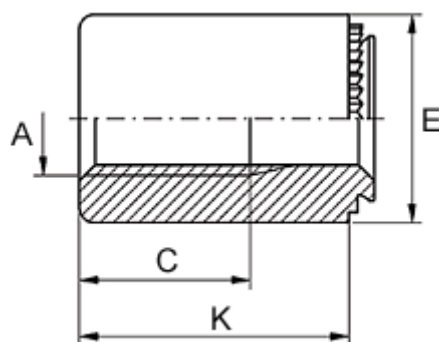

Female thread A	= M4
Height K	= 16
Min distance to edge	= 4.0
Outer diameter E	= 8
Plate thickness	= 1.5 to 2.3
Recommended bore diameter +0.05	= 5.00
Thread length	= 8.0